

NCP4523

CMOS 3CH-LDOs for RF Unit

The NCP4523 Series are multi voltage regulator ICs with high output voltage accuracy, extremely low supply current, low noise, low ON-resistance and high ripple rejection by CMOS process. The NCP4523 Series contain three voltage regulators. Each of these voltage regulators in the NCP4523 Series consists of a voltage reference unit, an error amplifier, resistors for setting output voltage, a current limit circuit and a chip enable circuit.

The chip enable function contributes to prolong battery life. Further, regulators in the NCP4523 Series are with low dropout voltage, excellent load transient response and line transient response, thus the NCP4523 series are very suitable for the power supply for hand-held communication equipment.

The output voltage of each regulator is fixed with high accuracy by laser trim.

Since the package for these ICs is SSOP-8, high density mounting of the ICs on boards is possible.

Features

- Ultra-Low Supply Current
- Low Standby Current
- Low Dropout Voltage
- High Ripple Rejection, Typical 70 dB ($f = 1.0$ kHz)
- High Output Voltage Accuracy, $\pm 2.0\%$
- Excellent Load Transient Response and Line Transient Response
- Small Package 8-Pin SSOP
- Maximum Input Voltage 6.0 V
- Pb-Free Packages are Available

Applications

- Power Source for Cellular Phones such as GSM, CDMA and Personal Handy-Phone System
- Power Source for Electrical Appliances such as Cameras, VCRs, Camcorders, etc.
- Power Source for Battery-Powered Equipment



ON Semiconductor®

<http://onsemi.com>

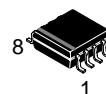

**SSOP-8
G SUFFIX
CASE 487**

MARKING DIAGRAM

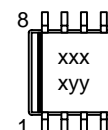

xxxx = Product Code
yy = Lot Number

PIN ASSIGNMENT

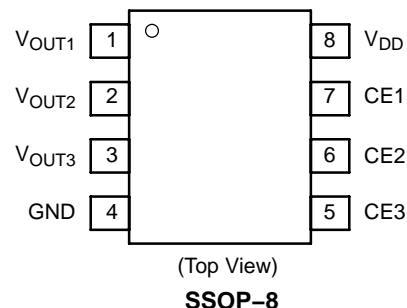

ORDERING INFORMATION

See detailed ordering and shipping information in the package dimensions section on page 22 of this data sheet.

DEVICE MARKING INFORMATION

See general marking information in the device marking section on page 22 of this data sheet.

NCP4523

PIN DESCRIPTION

Pin Number	Symbol	Description
NCP4523G SSOP-8		
1	V _{OUT1}	Output Pin
2	V _{OUT2}	Output Pin
3	V _{OUT3}	Output Pin
4	GND	Ground Pin
5	CE3	Chip Enable Pin
6	CE2	Chip Enable Pin
7	CE1	Chip Enable Pin
8	V _{DD}	Input Pin

ABSOLUTE MAXIMUM RATINGS

Rating	Symbol	Value	Unit
Input Voltage	V _{IN}	7.0	V
Input Voltage (CE Pin)	CE	-0.3 ~ V _{IN} + 0.3	V
Output Voltage	V _{OUT}	-0.3 ~ V _{IN} + 0.3	V
Output Current (V _{OUT1})	I _{OUT1}	200	mA
Output Current (V _{OUT2})	I _{OUT2}	100	mA
Output Current (V _{OUT3})	I _{OUT3}	100	mA
Power Dissipation	P _D	300	mW
Operating Temperature Range	T _{opt}	-40 ~ 85	°C
Storage Temperature Range	T _{stg}	-55 ~ 125	°C
Electrostatic Discharge Sensitivity (ESD) Human Body Model (HBM) Machine Model (MM)	ESD	2000 200	V

Maximum ratings are those values beyond which device damage can occur. Maximum ratings applied to the device are individual stress limit values (not normal operating conditions) and are not valid simultaneously. If these limits are exceeded, device functional operation is not implied, damage may occur and reliability may be affected.

NCP4523

ELECTRICAL CHARACTERISTICS

VR1 ($T_{opt} = 25^{\circ}\text{C}$)

Characteristics	Conditions	Symbol	Min	Typ	Max	Unit
Output Voltage	$V_{IN} - V_{OUT} = 1.0\text{ V}$ $1.0\text{ mA} \leq I_{OUT} \leq 30\text{ mA}$	V_{OUT}	$\times 0.98$	–	$\times 1.02$	V
Output Current	$V_{IN} - V_{OUT} = 1.0\text{ V}$	I_{OUT}	150	–	–	mA
Load Regulation	$V_{IN} - V_{OUT} = 1.0\text{ V}$ $1.0\text{ mA} \leq I_{OUT} \leq 80\text{ mA}$	$\Delta V_{OUT}/\Delta I_{OUT}$	–	12	40	mV
Dropout Voltage	Refer to Electrical Characteristic by Output Voltage (VR1)	V_{DIF}	–	–	–	–
Supply Current	$V_{IN} - V_{OUT} = 1.0\text{ V}$	I_{SS}	–	70	120	μA
Supply Current (Standby)	$V_{IN} - V_{OUT} = 1.0\text{ V}$ $V_{CE} = \text{GND}$	$I_{standby}$	–	0.1	1.0	μA
Line Regulation	$V_{OUT} + 0.5\text{ V} \leq V_{IN} \leq 6.0\text{ V}$ $I_{OUT} = 30\text{ mA}$	$\Delta V_{OUT}/\Delta V_{IN}$	–	0.05	0.20	%/V
Ripple Rejection	$f = 1.0\text{ kHz}$, sinusoidal 0.5 Vp-p $V_{IN} - V_{OUT} = 1.0\text{ V}$	RR	–	70	–	dB
Input Voltage	–	V_{IN}	–	–	6.0	V
Output Voltage Temperature Coefficient	$I_{OUT} = 50\text{ mA}$ $-40^{\circ}\text{C} \leq T_{opt} \leq 85^{\circ}\text{C}$	$\Delta V_{OUT}/\Delta T$	–	± 100	–	ppm/ $^{\circ}\text{C}$
Short Current Limit	$V_{OUT} = 0\text{ V}$	I_{LIM}	–	50	–	mA
CE Pull-down Resistance	–	R_{DN}	2.5	5.0	10	$\text{M}\Omega$
CE Input Voltage "H"	–	V_{CEH}	1.5	–	V_{IN}	V
CE Input Voltage "L"	–	V_{CEL}	0.00	–	0.25	V
Output Noise	$\text{BW} = 10\text{ Hz} - 100\text{ kHz}$	e_n	–	60	–	μVrms

ELECTRICAL CHARACTERISTICS BY OUTPUT VOLTAGE (VR1)

Output Voltage V_{OUT} (V)	Dropout Voltage V_{DIF} (V)		
	Condition	Typ	Max
$2.0 \leq V_{OUT} \leq 2.4$	$I_{OUT} = 150\text{ mA}$	0.35	0.55
$2.5 \leq V_{OUT} \leq 2.7$		0.30	0.45
$2.8 \leq V_{OUT} \leq 3.3$		0.22	0.35

NCP4523

ELECTRICAL CHARACTERISTICS

VR2 ($T_{opt} = 25^{\circ}\text{C}$)

Characteristics	Conditions	Symbol	Min	Typ	Max	Unit
Output Voltage	$V_{IN} - V_{OUT} = 1.0\text{ V}$ $1.0\text{ mA} \leq I_{OUT} \leq 30\text{ mA}$	V_{OUT}	$\times 0.98$	–	$\times 1.02$	V
Output Current	$V_{IN} - V_{OUT} = 1.0\text{ V}$	I_{OUT}	80	–	–	mA
Load Regulation	$V_{IN} - V_{OUT} = 1.0\text{ V}$ $1.0\text{ mA} \leq I_{OUT} \leq 50\text{ mA}$	$\Delta V_{OUT}/\Delta I_{OUT}$	–	12	40	mV
Dropout Voltage	Refer to Electrical Characteristic by Output Voltage (VR2)	V_{DIF}	–	–	–	–
Supply Current	$V_{IN} - V_{OUT} = 1.0\text{ V}$	I_{SS}	–	70	120	μA
Supply Current (Standby)	$V_{IN} - V_{OUT} = 1.0\text{ V}$ $V_{CE} = \text{GND}$	$I_{standby}$	–	0.1	1.0	μA
Line Regulation	$V_{OUT} + 0.5\text{ V} \leq V_{IN} \leq 6.0\text{ V}$ $I \leq 30\text{ mA}$	$\Delta V_{OUT}/\Delta V_{IN}$	–	0.05	0.20	V
Ripple Rejection	$f = 1.0\text{ kHz}$, sinusoidal 0.5 Vp-p $V_{IN} - V_{OUT} = 1.0\text{ V}$	RR	–	70	–	dB
Input Voltage	–	V_{IN}	–	–	6.0	V
Output Voltage Temperature Coefficient	$I_{OUT} = 30\text{ mA}$ $-40^{\circ}\text{C} \leq T_{opt} \leq 85^{\circ}\text{C}$	$\Delta V_{OUT}/\Delta T$	–	± 100	–	ppm/ $^{\circ}\text{C}$
Short Current Limit	$V_{OUT} = 0\text{ V}$	I_{LIM}	–	50	–	mA
CE Pull-down Resistance	–	R_{DN}	2.5	5.0	10	$\text{M}\Omega$
CE Input Voltage "H"	–	V_{CEH}	1.5	–	V_{IN}	V
CE Input Voltage "L"	–	V_{CEL}	0.00	–	0.25	V
Output Noise	$\text{BW} = 10\text{ Hz} - 100\text{ kHz}$	e_n	–	60	–	μVrms

ELECTRICAL CHARACTERISTICS BY OUTPUT VOLTAGE (VR2)

Output Voltage V_{OUT} (V)	Dropout Voltage V_{DIF} (V)		
	Condition	Typ	Max
$2.0 \leq V_{OUT} \leq 2.4$	$I_{OUT} = 80\text{ mA}$	0.22	0.38
$2.5 \leq V_{OUT} \leq 2.7$		0.20	0.38
$2.8 \leq V_{OUT} \leq 3.3$		0.16	0.24

NCP4523

ELECTRICAL CHARACTERISTICS

VR3 ($T_{opt} = 25^{\circ}\text{C}$)

Characteristics	Conditions	Symbol	Min	Typ	Max	Unit
Output Voltage	$V_{IN} - V_{OUT} = 1.0\text{ V}$ $1.0\text{ mA} \leq I_{OUT}$	V_{OUT}	$\times 0.98$	–	$\times 1.02$	V
Output Current	$V_{IN} - V_{OUT} = 1.0\text{ V}$	I_{OUT}	80	–	–	mA
Load Regulation	$V_{IN} - V_{OUT} = 1.0\text{ V}$ $1.0\text{ mA} \leq I_{OUT} \leq 50\text{ mA}$	$\Delta V_{OUT}/\Delta I_{OUT}$	–	12	40	mV
Dropout Voltage	Refer to Electrical Characteristic by Dropout Voltage (VR3)	V_{DIF}	–	–	–	–
Supply Current	$V_{OUT} + 0.5\text{ V} \leq V_{IN} \leq 6.0\text{ V}$ $I_{OUT} = 30\text{ mA}$	I_{SS}	–	70	120	μA
Supply Current (Standby)	$f = 1.0\text{ kHz}$, sinusoidal 0.5 V_{p-p} $V_{IN} - V_{OUT} = 1.0\text{ V}$	$I_{standby}$	–	0.1	1.0	μA
Line Regulation	–	$\Delta V_{OUT}/\Delta V_{IN}$	–	0.05	0.20	%/V
Ripple Rejection	$I_{OUT} = 30\text{ mA}$ $-40^{\circ}\text{C} \leq T_{opt} \leq 85^{\circ}\text{C}$	RR	–	70	–	dB
Input Voltage	$V_{OUT} = 0\text{ V}$	V_{IN}	–	–	6.0	V
Output Voltage Temperature Coefficient	–	$\Delta V_{OUT}/\Delta T$	–	± 100	–	ppm/ $^{\circ}\text{C}$
Short Current Limit	BW = 10 Hz – 100 kHz	I_{LIM}	–	50	–	mA
CE Pull-down Resistance	–	R_{DN}	2.5	5.0	10	$\text{M}\Omega$
CE Input Voltage "H"	–	V_{CEH}	1.5	–	V_{IN}	V
CE Input Voltage "L"	–	V_{CEL}	0.00	–	0.25	V
Output Noise	–	e_n	–	60	–	μV_{rms}

ELECTRICAL CHARACTERISTICS BY OUTPUT VOLTAGE (VR3)

Output Voltage V_{OUT} (V)	Dropout Voltage V_{DIF} (V)		
	Condition	Typ	Max
$2.0 \leq V_{OUT} \leq 2.4$	$I_{OUT} = 80\text{ mA}$	0.24	0.38
$2.5 \leq V_{OUT} \leq 2.7$		0.22	0.28
$2.8 \leq V_{OUT} \leq 3.3$		0.16	0.24

NCP4523

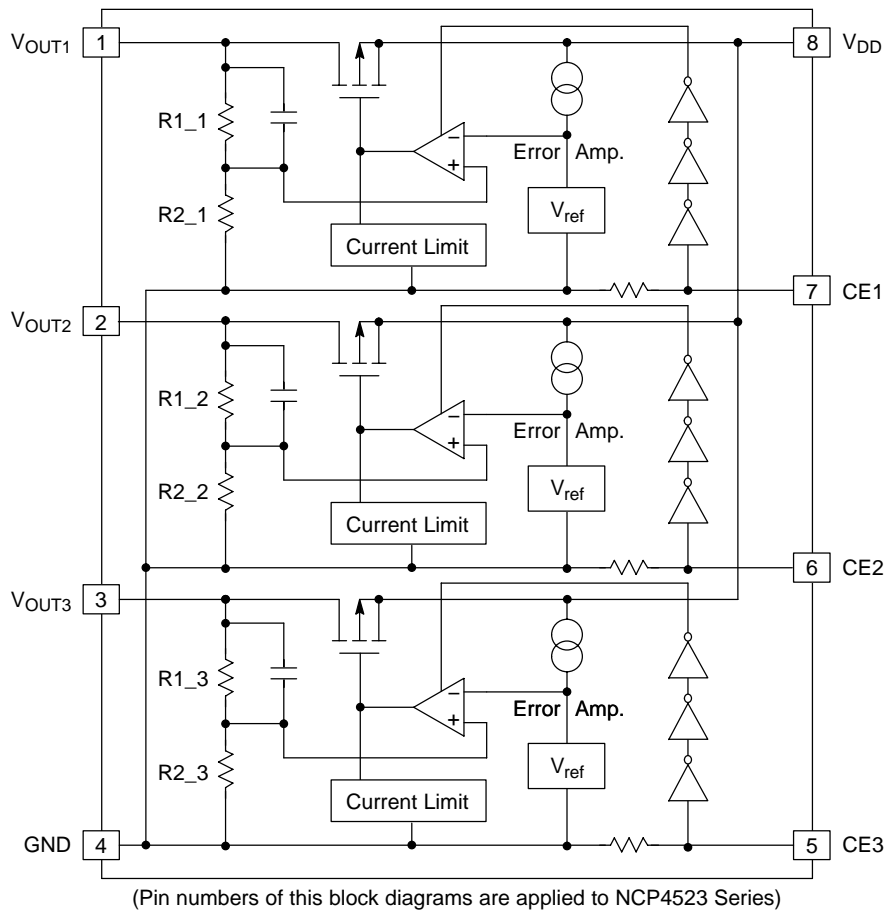

Figure 1. Block Diagram

NCP4523

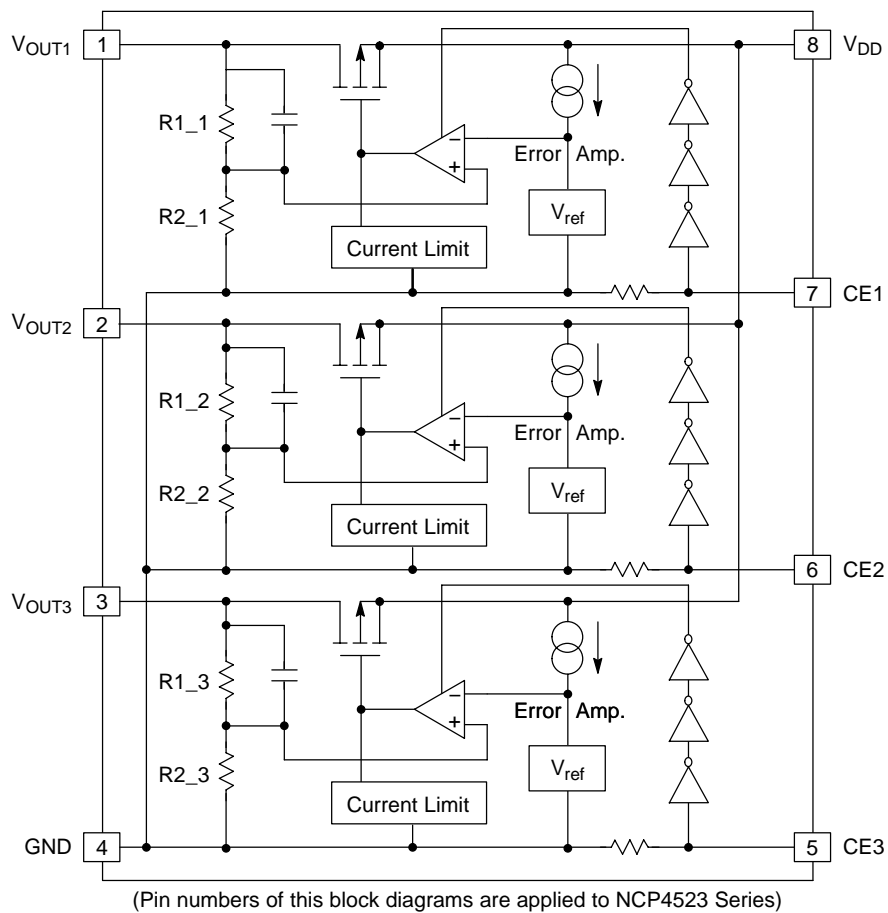

Figure 2. Operation

Fluctuation of each regulator's output voltage, or $V_{OUT1,2,3}$ is detected individually. Then it is put back to an error amplifier through feedback resistors, or $R1_1$, $R2_1$, $R1_2$, $R2_2$, $R1_3$, $R2_3$ and compared with a reference voltage and compensated for the result and make a constant voltage.

In each regulator, short protection is made with a current limit circuit and standby mode is available by a chip enable circuit.

NCP4523

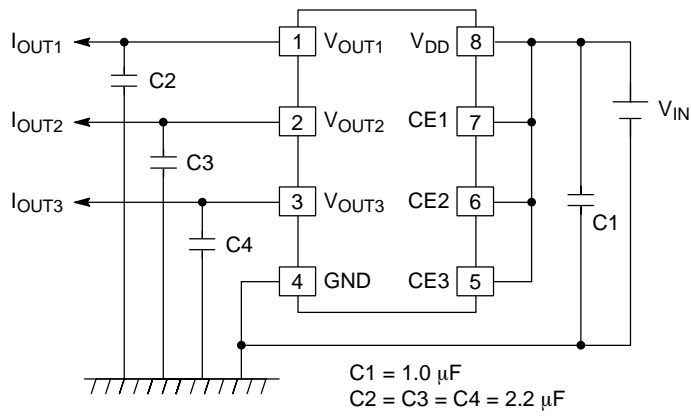

Figure 3. Basic Test Circuit

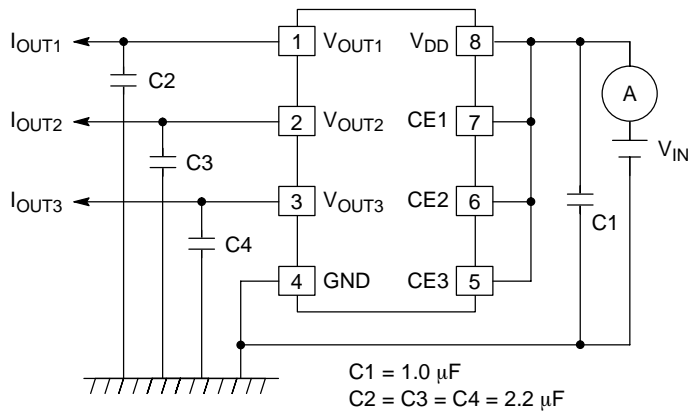

Figure 4. Test Circuit for Supply Current

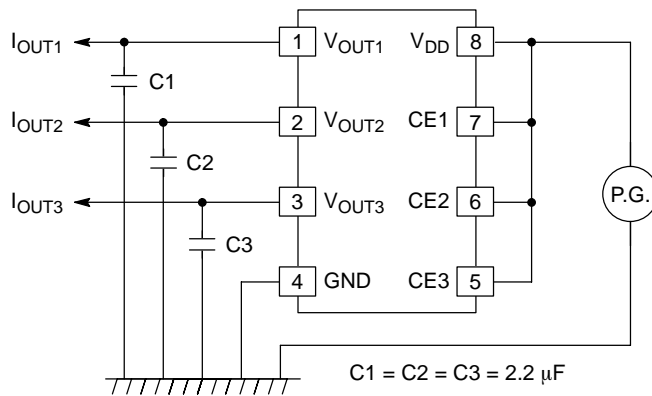

Figure 5. Test Circuit for Line Transient Response

NCP4523

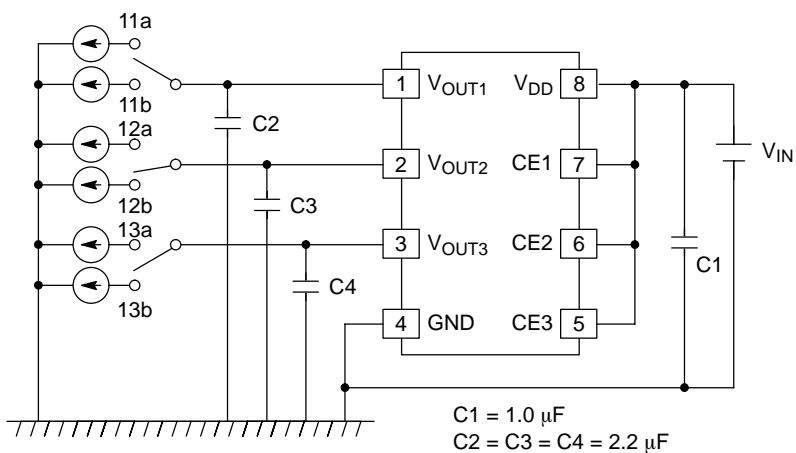

Figure 6. Test Circuit for Load Transient Response

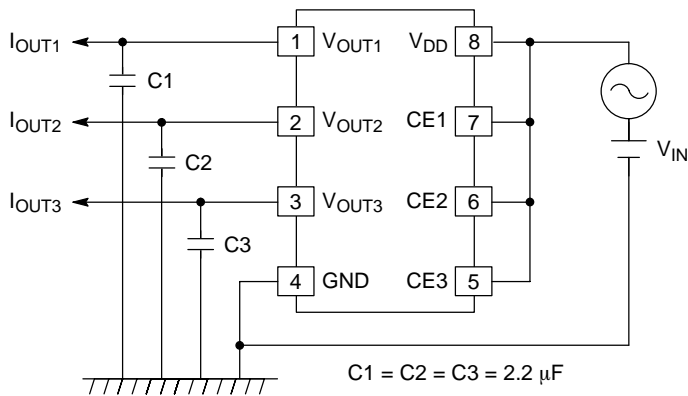

Figure 7. Test Circuit for Ripple Rejection

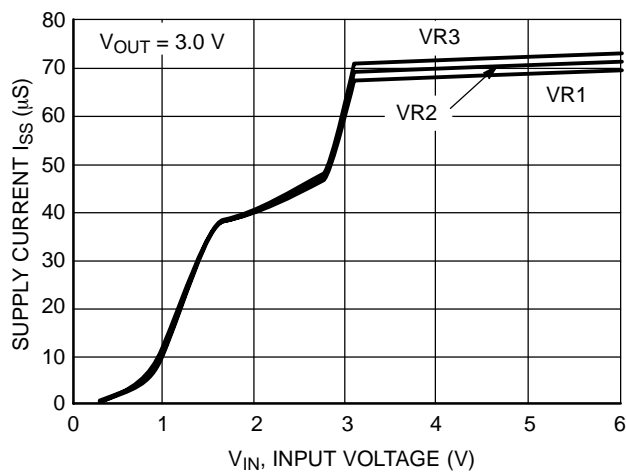

Figure 8. Supply Current vs Input Voltage

NCP4523

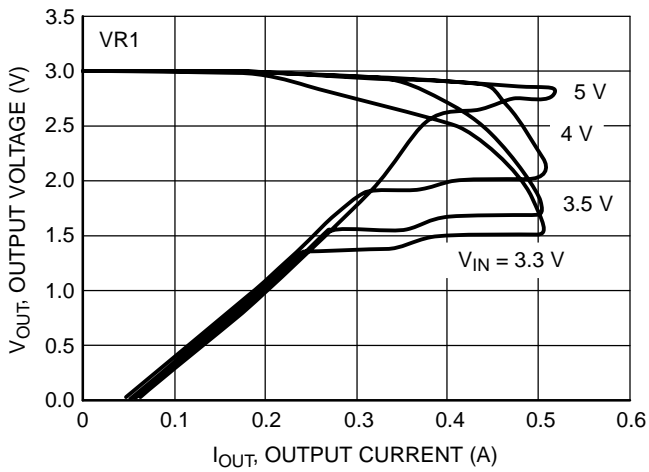

Figure 9. Output Voltage vs. Output Current

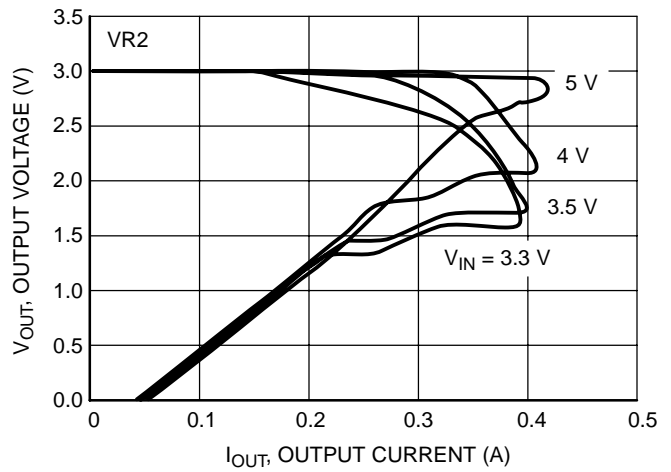

Figure 10. Output Voltage vs. Output Current

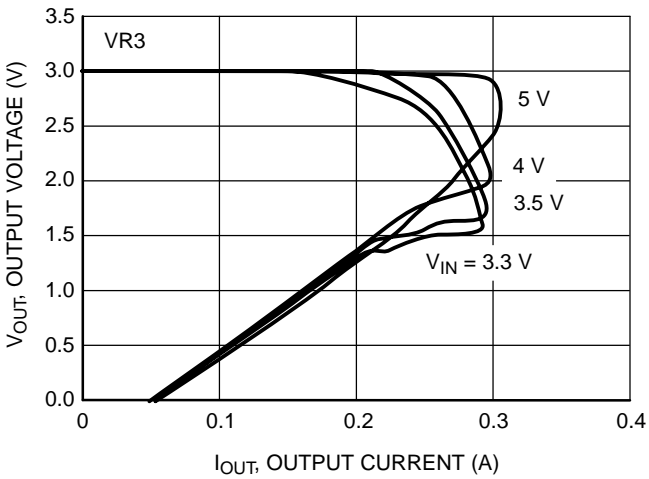

Figure 11. Output Voltage vs. Output Current

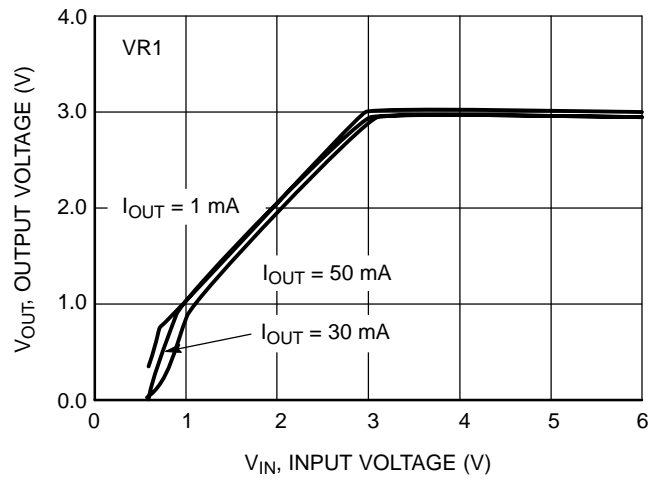

Figure 12. Output Voltage vs. Input Voltage

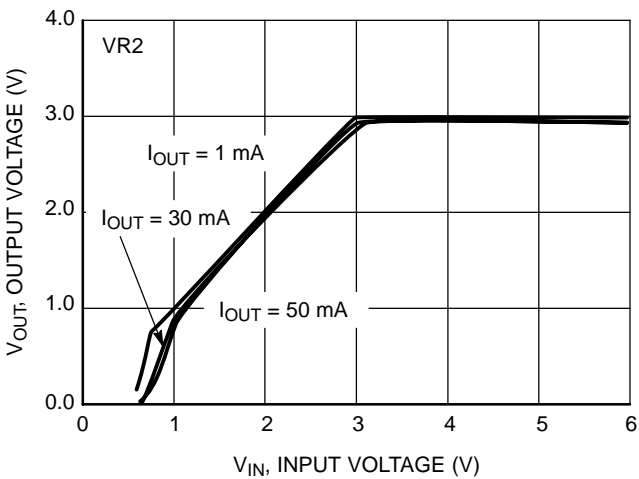

Figure 13. Output Voltage vs. Input Voltage

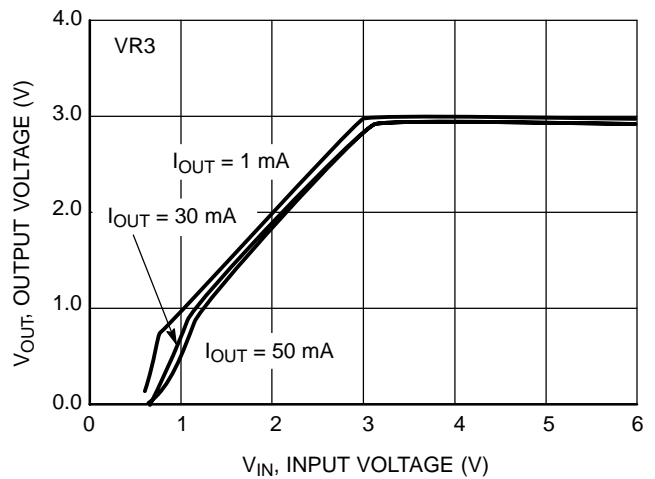

Figure 14. Output Voltage vs. Input Voltage

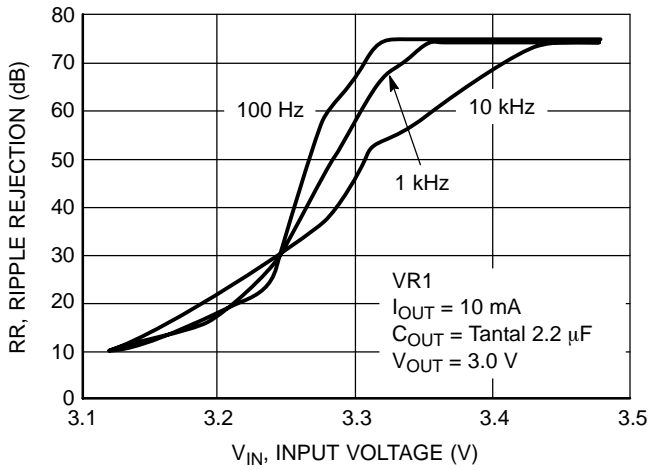

Figure 15. Ripple Rejection vs. Input Voltage (DC Bias)

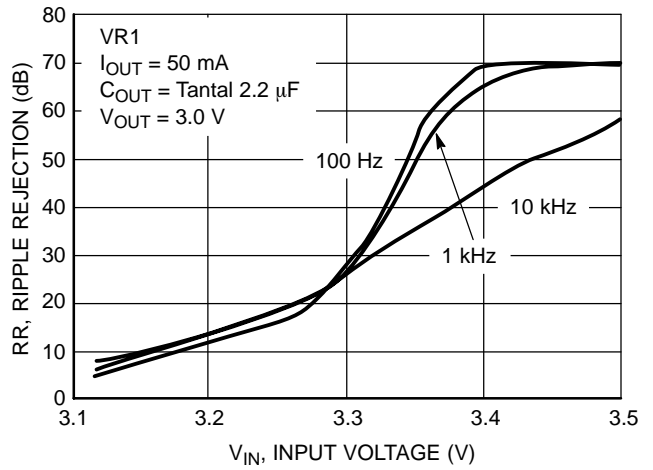

Figure 16. Ripple Rejection vs. Input Voltage (DC Bias)

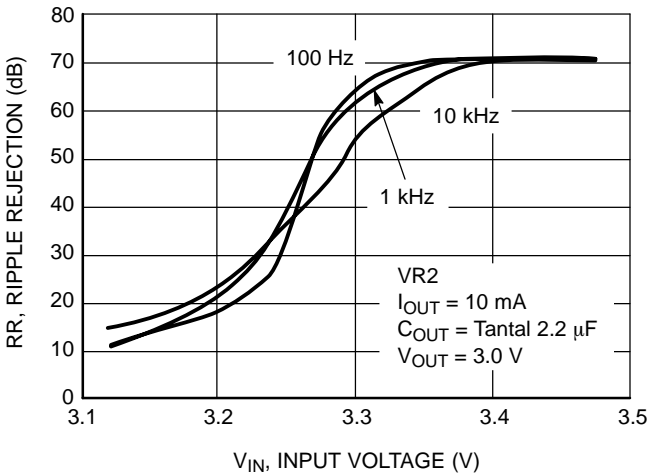

Figure 17. Ripple Rejection vs. Input Voltage (DC Bias)

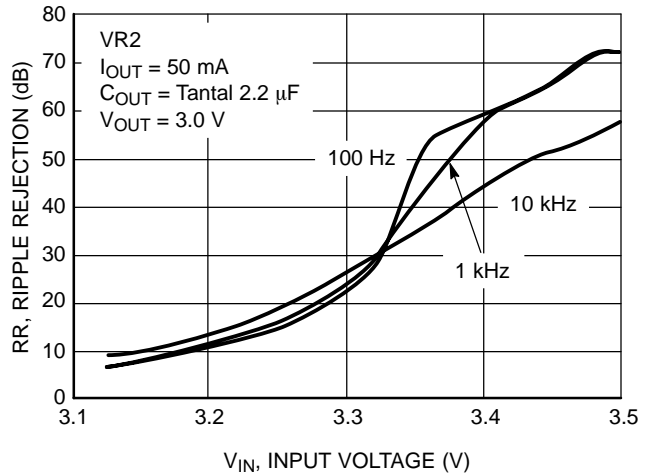

Figure 18. Ripple Rejection vs. Input Voltage (DC Bias)

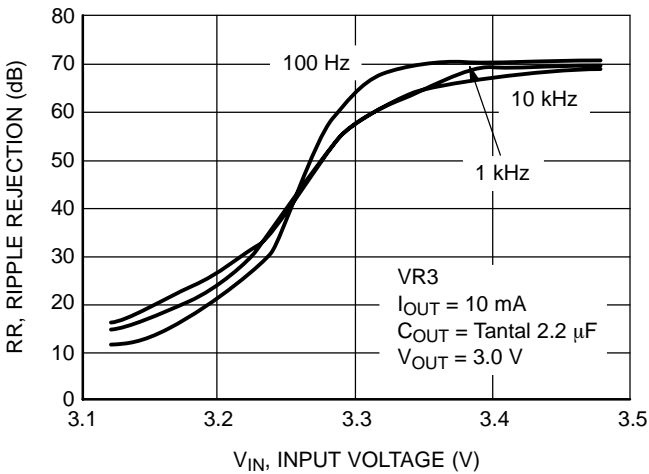

Figure 19. Ripple Rejection vs. Input Voltage (DC Bias)

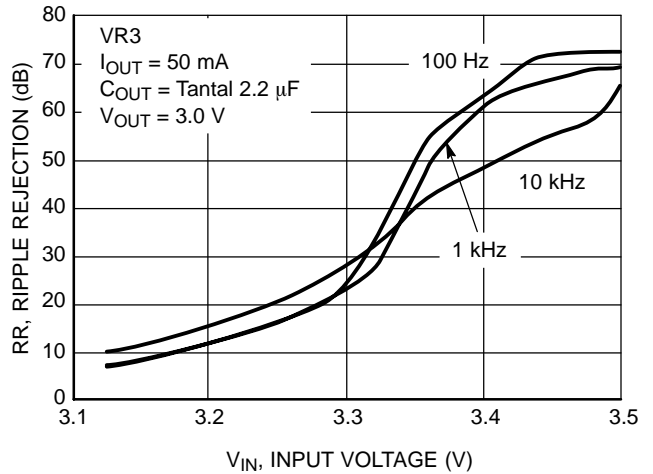

Figure 20. Ripple Rejection vs. Input Voltage (DC Bias)

NCP4523

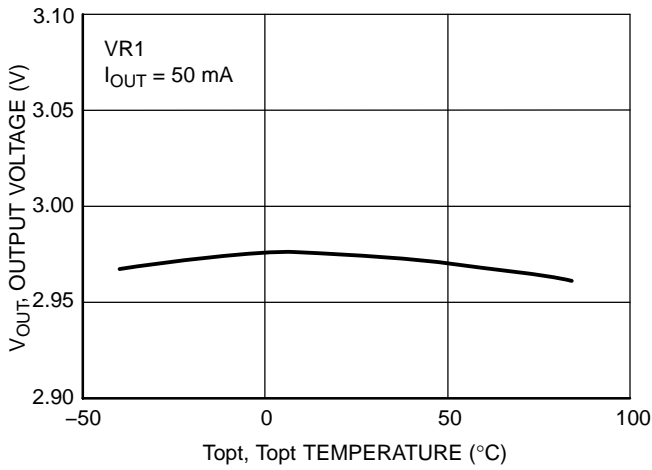

Figure 21. Output Voltage vs. Temperature

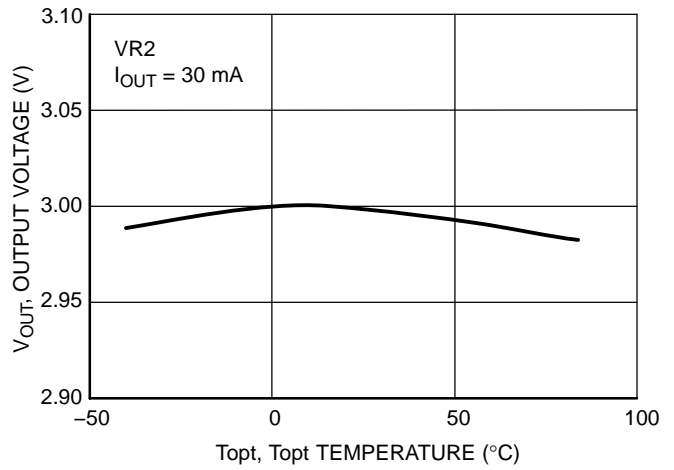

Figure 22. Output Voltage vs. Temperature

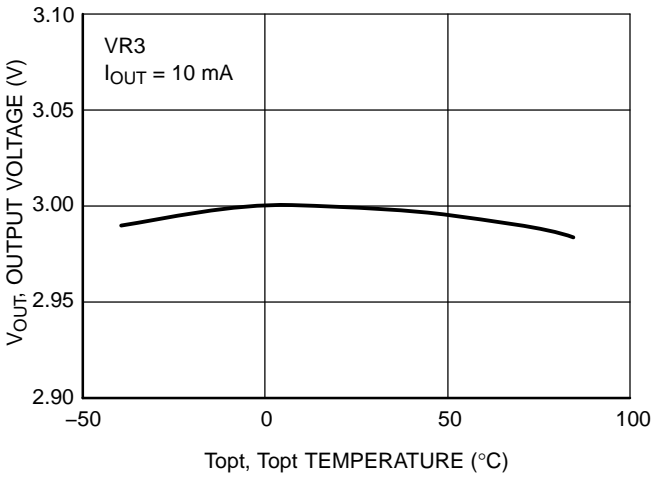

Figure 23. Output Voltage vs. Temperature

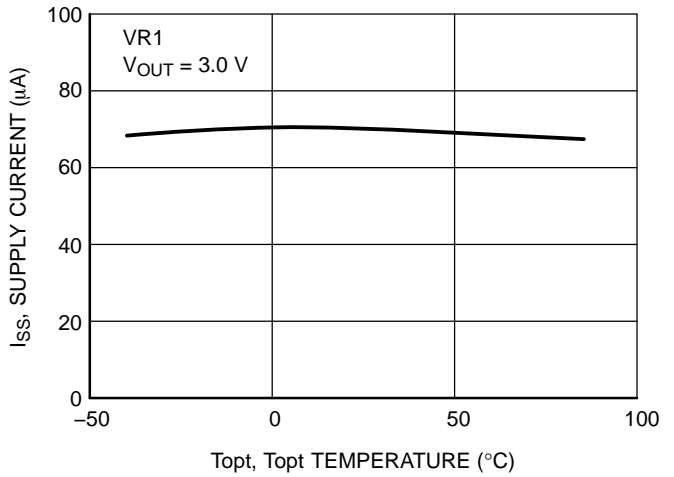

Figure 24. Supply Current vs. Temperature

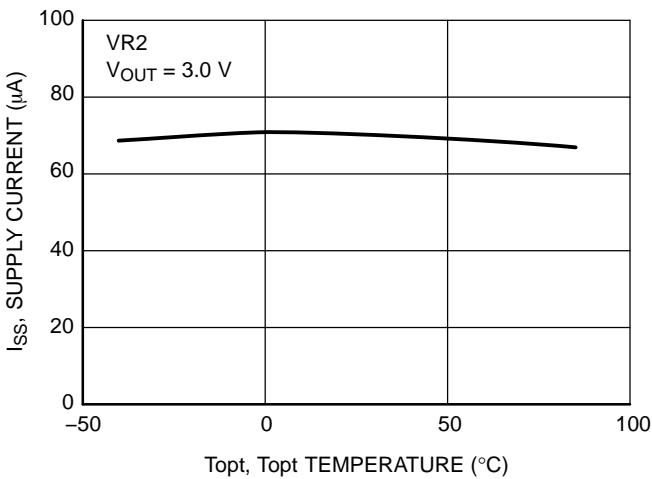

Figure 25. Supply Current vs. Temperature

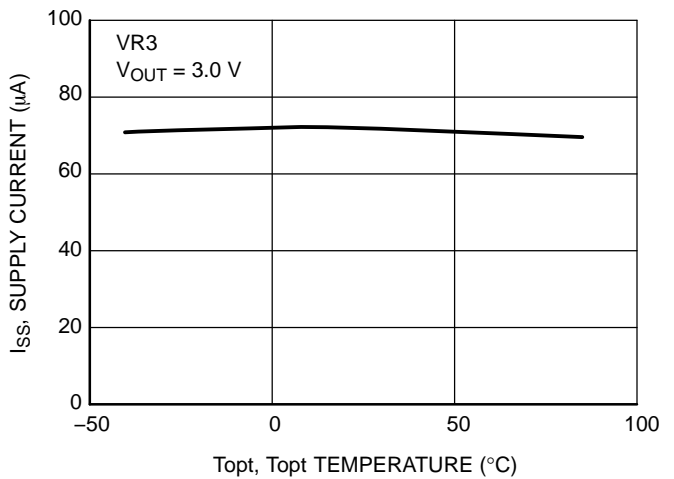

Figure 26. Supply Current vs. Temperature

NCP4523

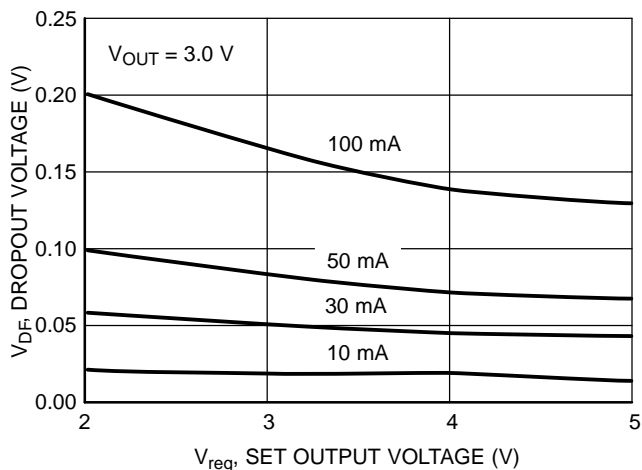

Figure 27. Dropout Voltage vs. Set Output Voltage

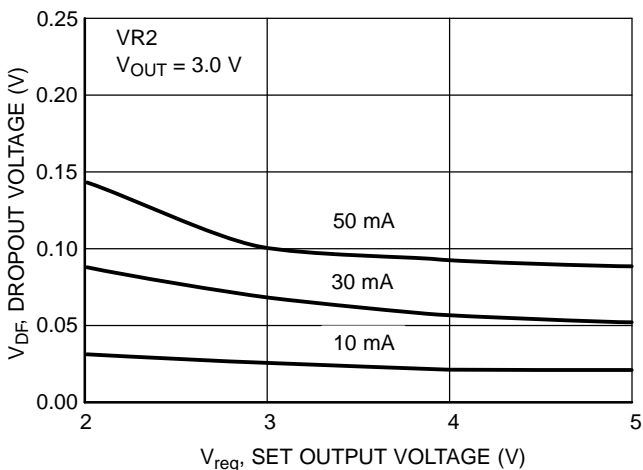

Figure 28. Dropout Voltage vs. Set Output Voltage

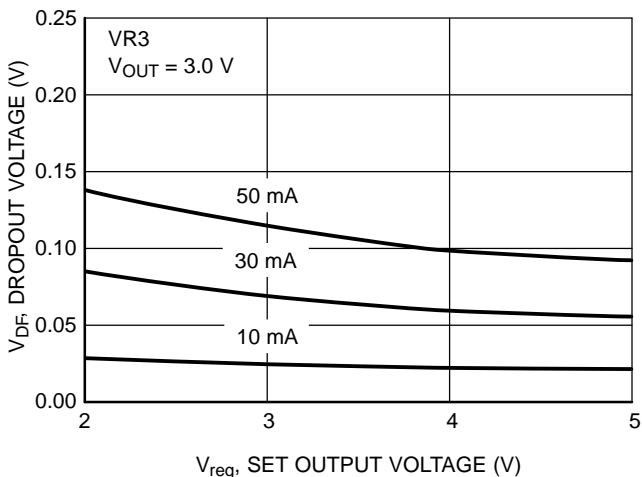

Figure 29. Dropout Voltage vs. Set Output Voltage

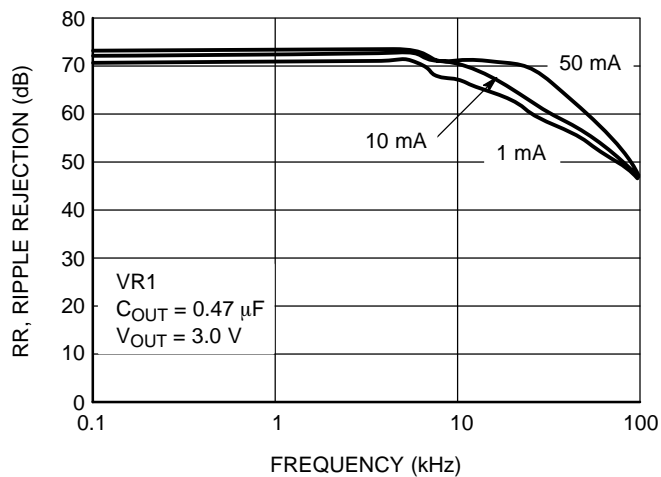

Figure 30. Ripple Rejection vs. Frequency

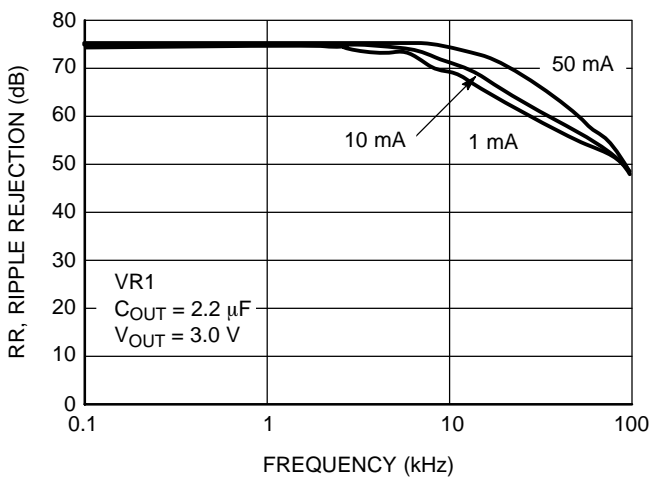

Figure 31. Ripple Rejection vs. Frequency

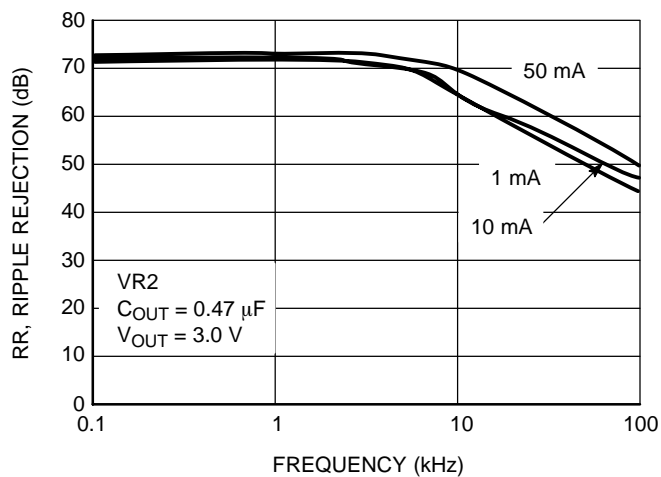

Figure 32. Ripple Rejection vs. Frequency

NCP4523

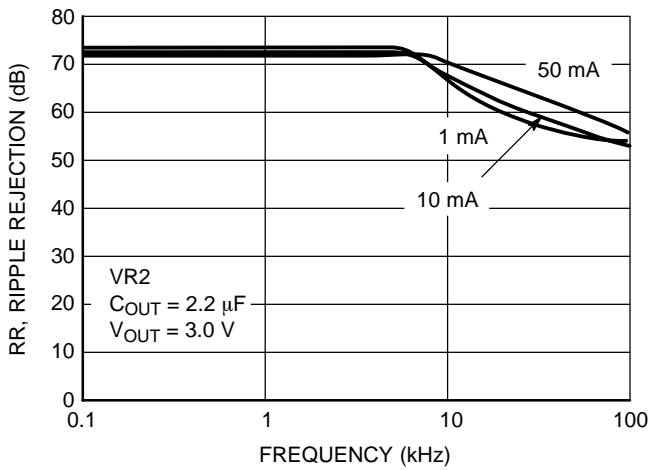

Figure 33. Ripple Rejection vs. Frequency

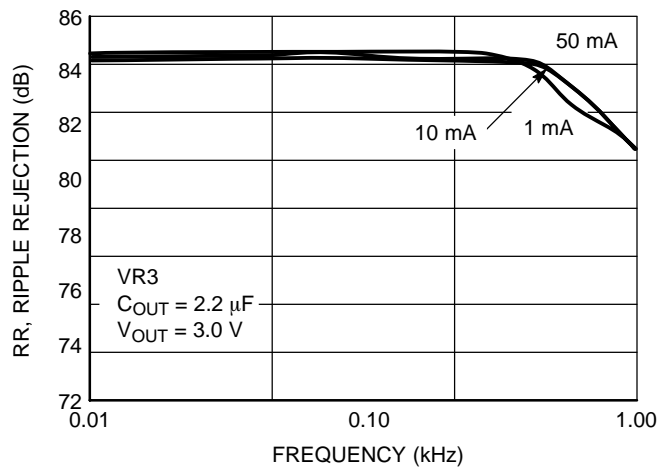

Figure 34. Ripple Rejection vs. Frequency

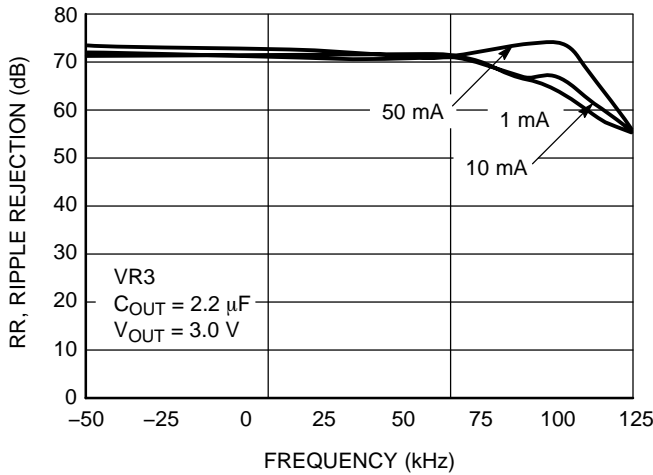

Figure 35. Ripple Rejection vs. Frequency

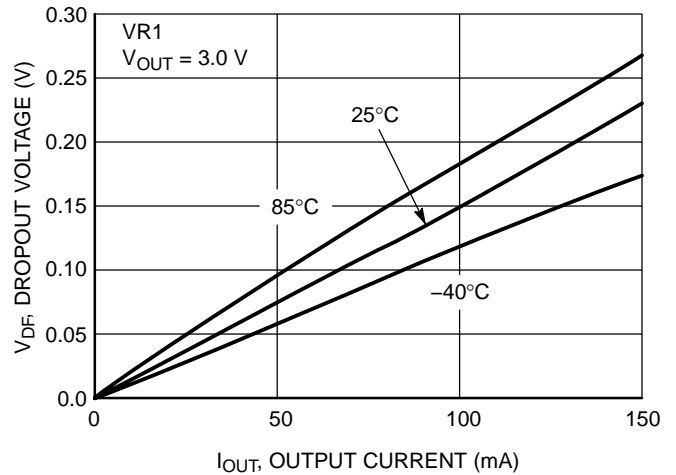

Figure 36. Dropout Voltage vs. Output Current

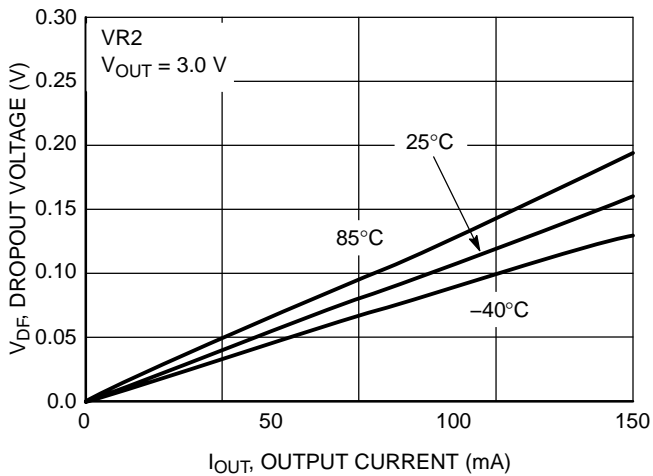

Figure 37. Dropout Voltage vs. Output Current

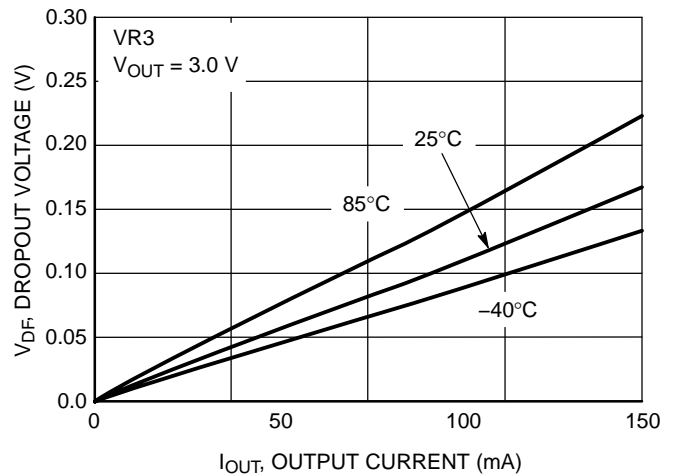

Figure 38. Dropout Voltage vs. Output Current

NCP4523

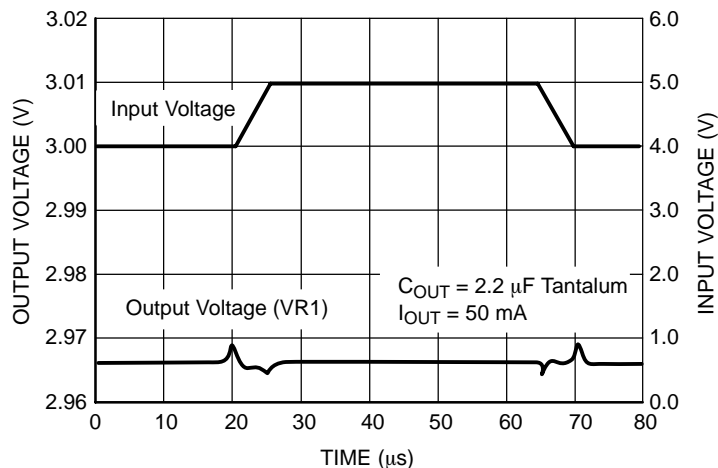

Figure 39. Line Transient Response

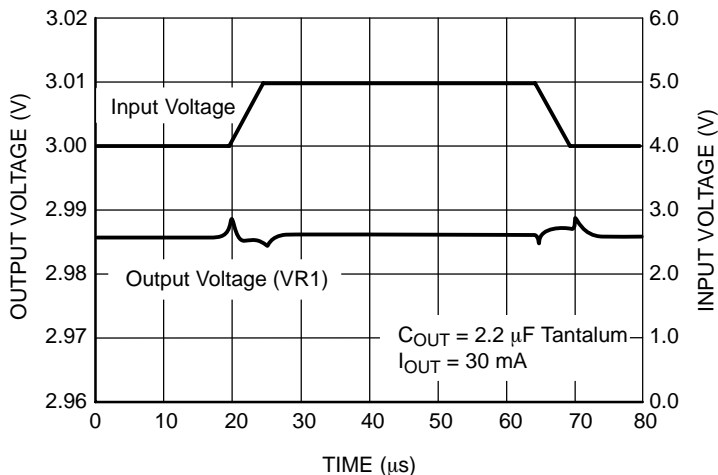

Figure 40. Line Transient Response

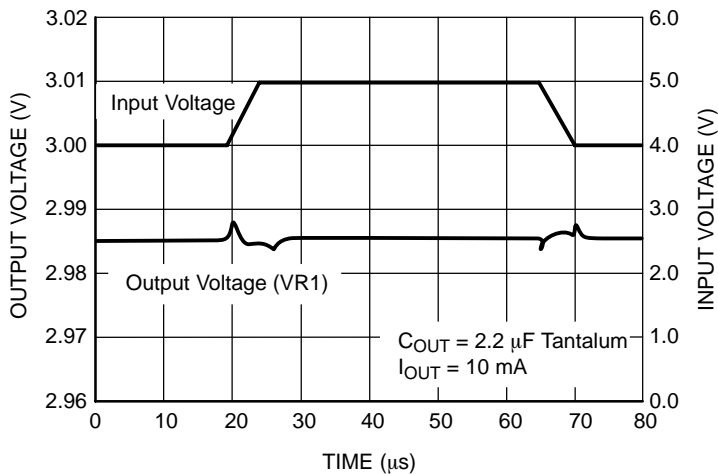

Figure 41. Line Transient Response

NCP4523

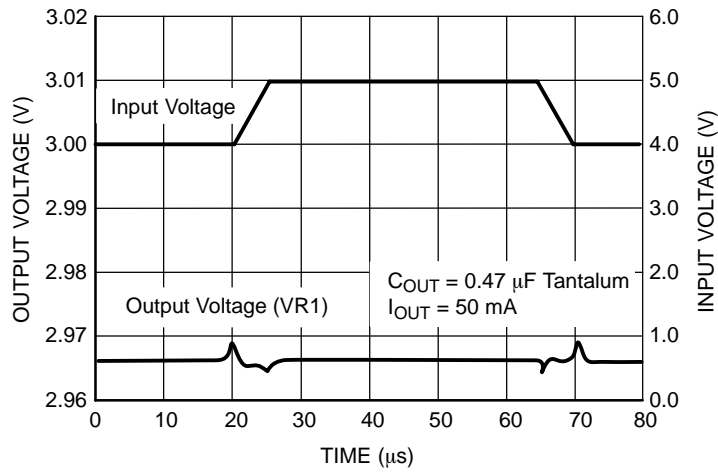

Figure 42. Line Transient Response

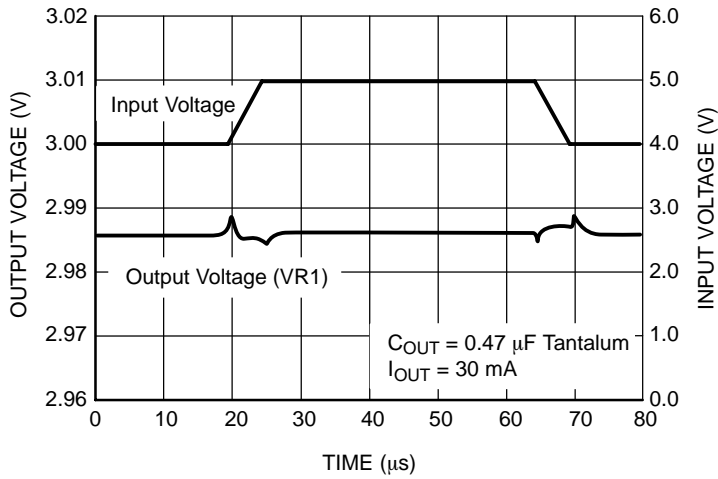

Figure 43. Line Transient Response

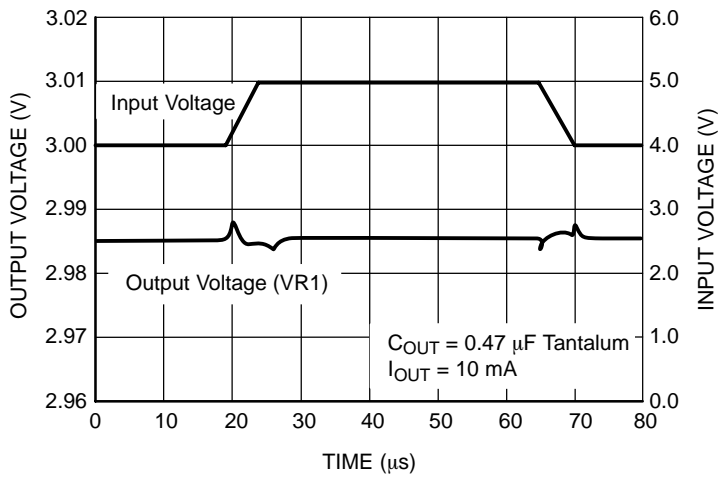

Figure 44. Line Transient Response

NCP4523

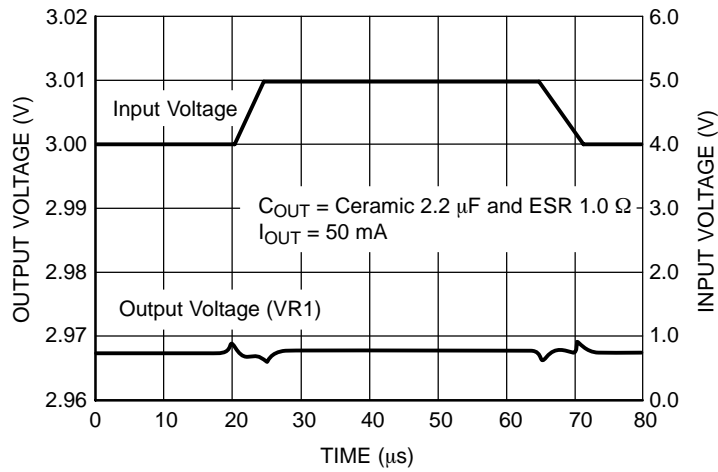

Figure 45. Line Transient Response

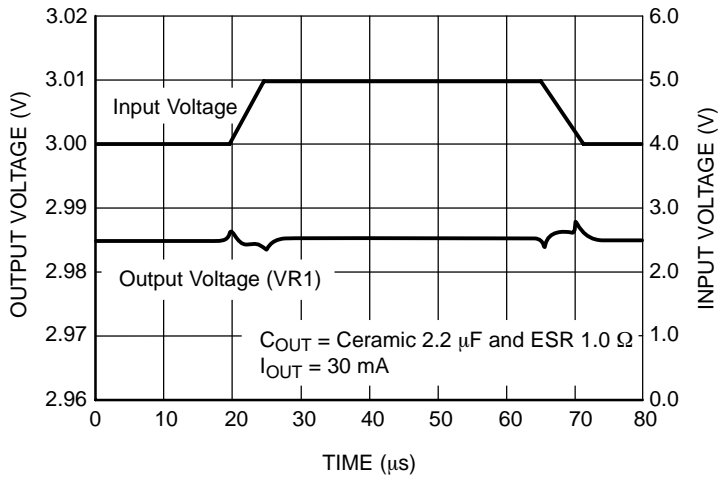

Figure 46. Line Transient Response

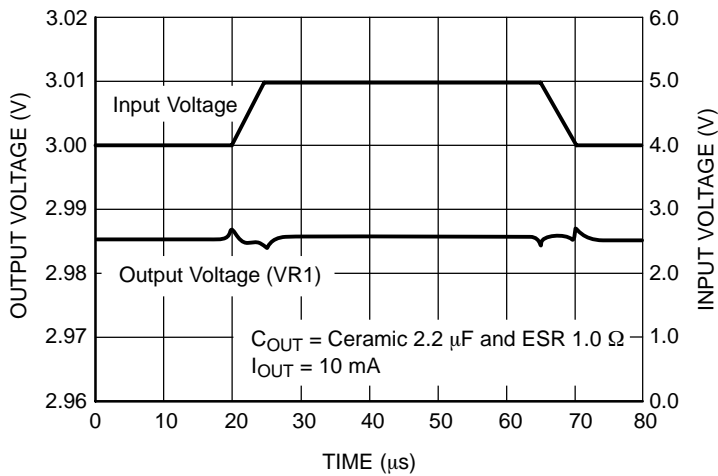

Figure 47. Line Transient Response

NCP4523

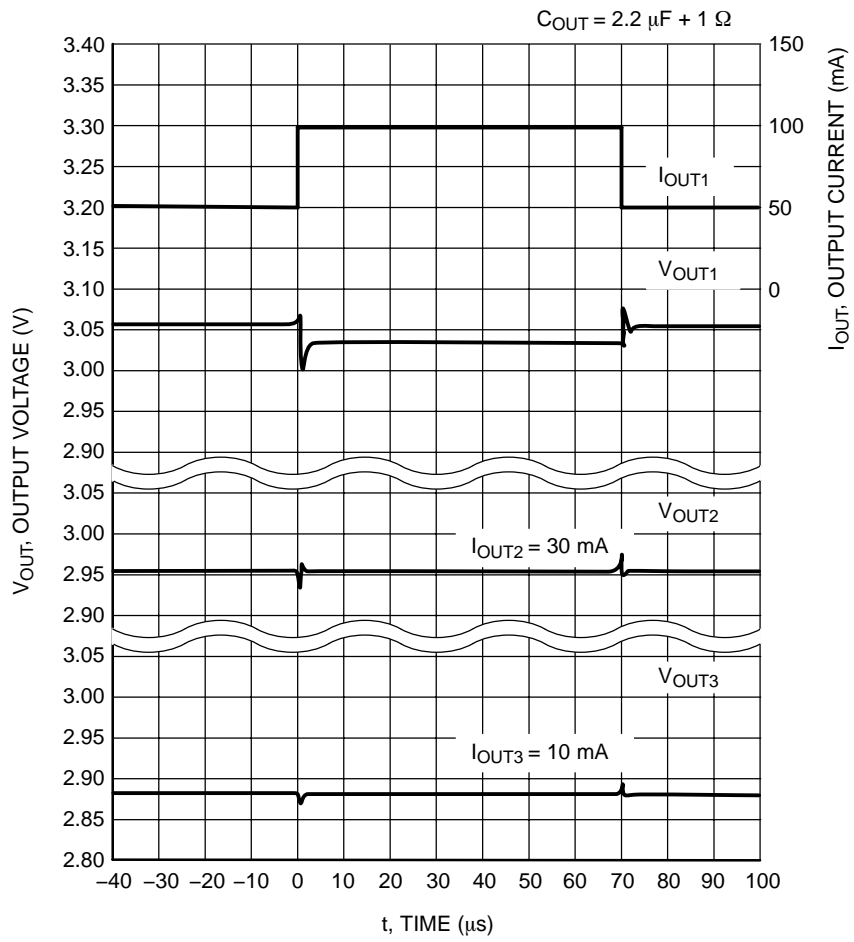

Figure 48. Load Transient Response

NCP4523

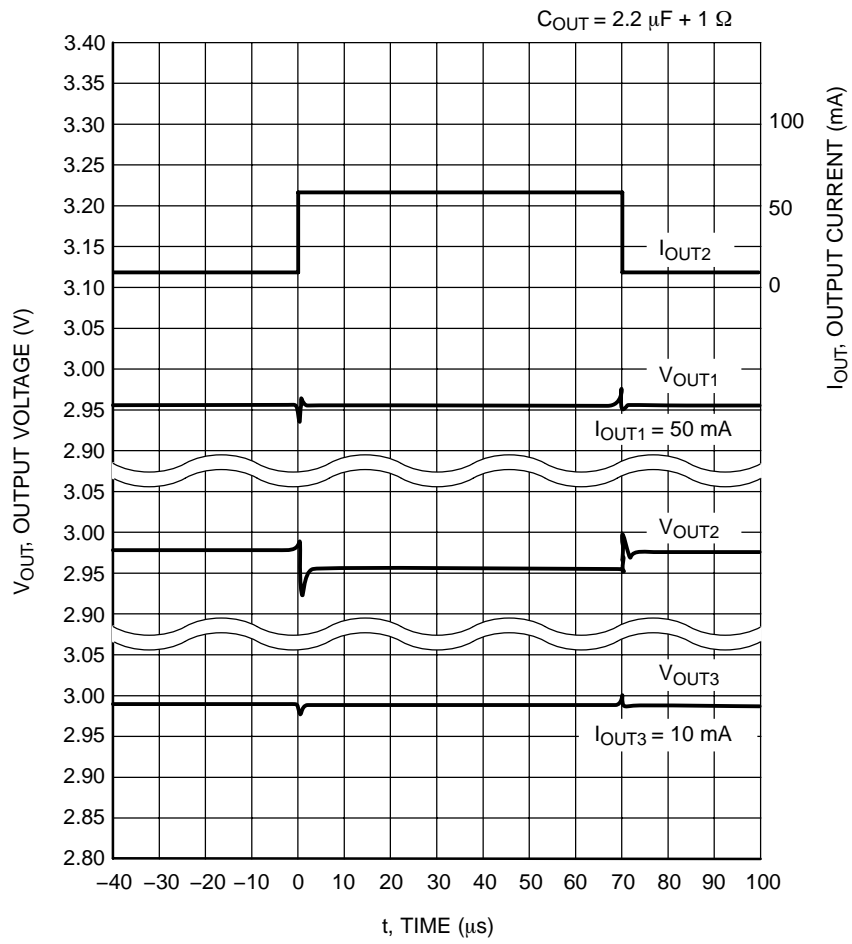

Figure 49. Load Transient Response

NCP4523

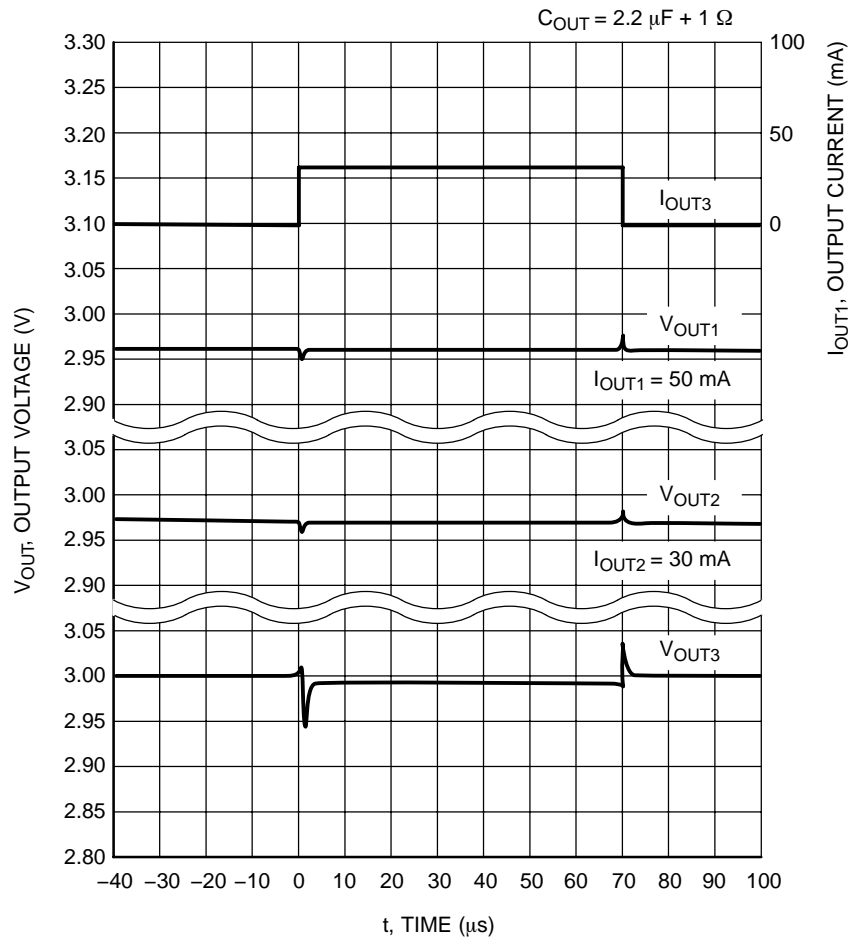

Figure 50. Load Transient Response

Technical Notes

(Pin numbers of the diagram below are applied to NCP4523)

To use this IC with ceramic capacitors, ESR should be set in the range of the following graphs. Test circuit for Noise level measurement is shown below.

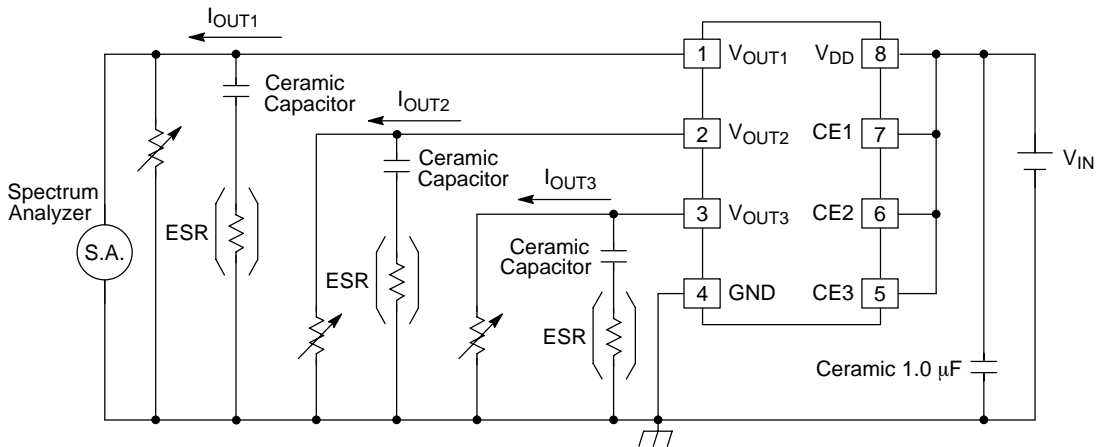

Figure 51.

NCP4523

Noise level is measured with a spectrum analyzer and hatched area shows stable areas of which noise level is approximately equal or less than $40 \mu\text{V}$ (Avg.). The relation between Load Current (I_{OUT}) and Equivalent Series Resistors (ESR) value of external output capacitor with the stable area is shown below.

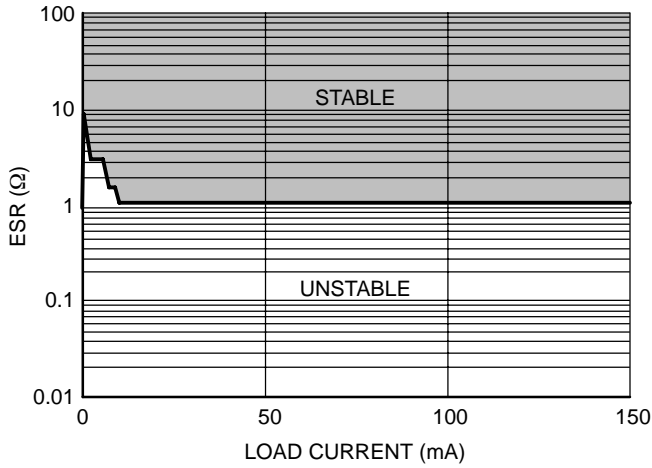

Figure 52. Ceramic Capacitor 1.0 μF

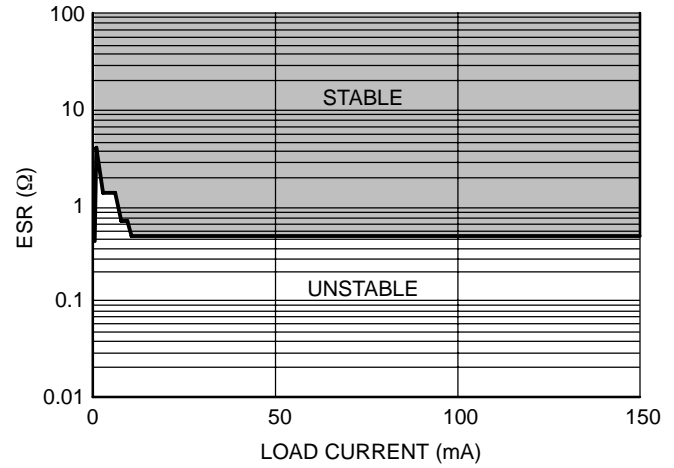

Figure 53. Ceramic Capacitor 2.2 μF

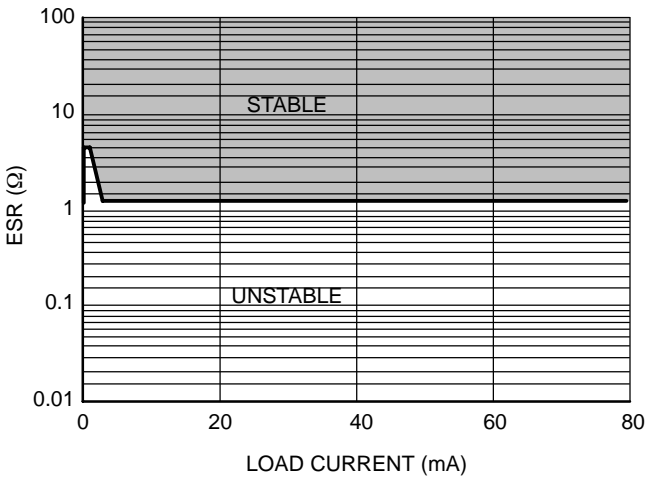

Figure 54. Ceramic Capacitor 1.0 μF

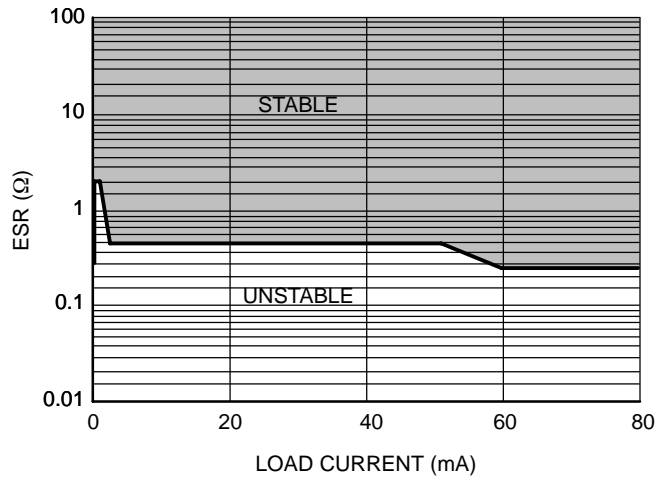

Figure 55. Ceramic Capacitor 2.2 μF

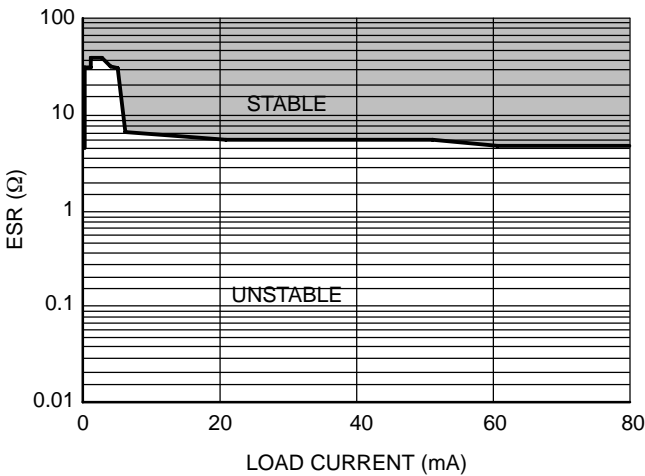

Figure 56. Ceramic Capacitor 1.0 μF

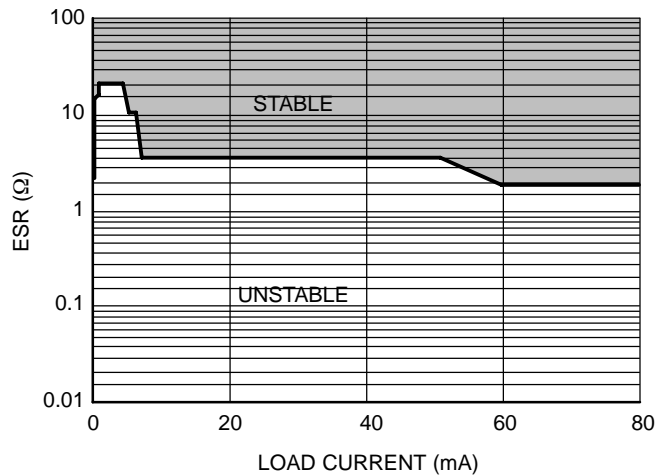

Figure 57. Ceramic Capacitor 2.2 μF

NCP4523

ORDERING INFORMATION

Device	S/N for Voltage Setting	Output Voltage			Marking	Package	Shipping†
		VR1	VR2	VR2	Product Code		
NCP4523G1T1	1	2.8	2.8	2.8	B01A	SSOP-8	3000 Tape and Reel
NCP4523G1T1G	1	2.8	2.8	2.8	B01A	SSOP-8 (Pb-Free)	3000 Tape and Reel
NCP4523G3T1	3	3.0	3.0	3.0	B03A	SSOP-8	3000 Tape and Reel
NCP4523G3T1G	3	3.0	3.0	3.0	B03A	SSOP-8 (Pb-Free)	3000 Tape and Reel
NCP4523G20T1	20	2.35	2.8	2.8	B20A	SSOP-8	3000 Tape and Reel
NCP4523G20T1G	20	2.35	2.8	2.8	B20A	SSOP-8 (Pb-Free)	3000 Tape and Reel

†For information on tape and reel specifications, including part orientation and tape sizes, please refer to our Tape and Reel Packaging Specification Brochure, BRD8011/D.

NCP4523

PACKAGE DIMENSIONS

SSOP-8
G SUFFIX
CASE 487-01
ISSUE O

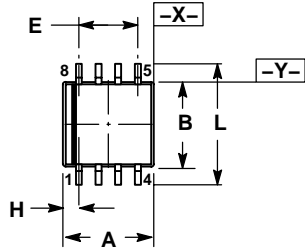

NOTES:

1. DIMENSIONING AND TOLERANCING PER ANSI Y14.5M, 1982.
2. CONTROLLING DIMENSION: INCH.
3. DIMENSION D APPLIES TO PLATED TERMINAL AND IS MEASURED BETWEEN 0.25 AND 0.30 MM FROM TERMINAL.
4. COPLANARITY APPLIES TO THE EXPOSED PAD AS WELL AS THE TERMINALS.

DIM	INCHES		MILLIMETERS	
	MIN	MAX	MIN	MAX
A	0.106	0.122	2.70	3.10
B	0.102	0.118	2.60	3.00
C	0.039	0.051	1.00	1.30
D	0.004	0.012	0.10	0.30
E	0.073	0.081	1.85	2.05
F	0.012	0.024	0.30	0.60
G	0.026 TYP		0.65 TYP	
H	0.019 TYP		0.475 TYP	
J	0.004	0.006	0.11	0.14
K	0.000	0.008	0.00	0.20
L	0.150	0.165	3.80	4.20

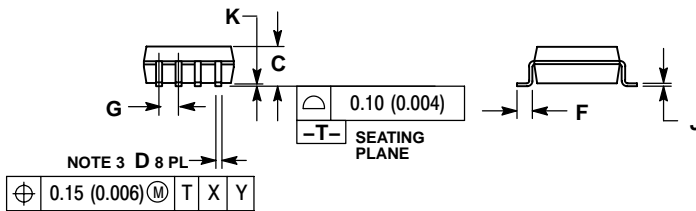

SOLDERING FOOTPRINT*

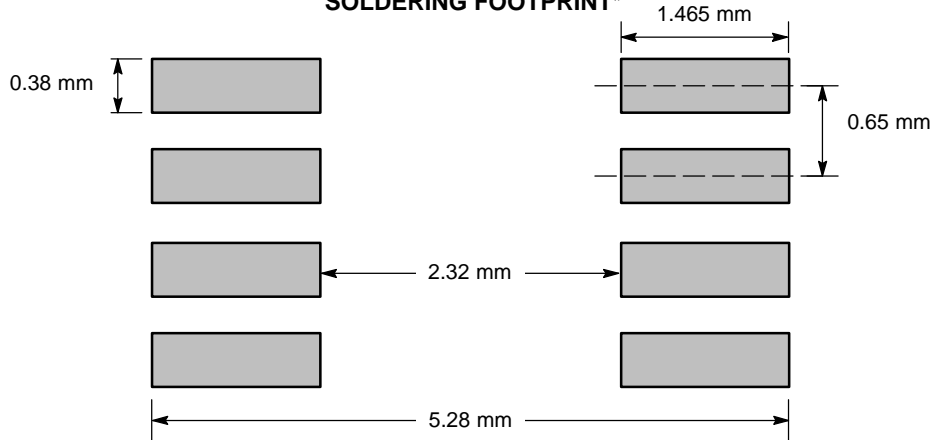

*For additional information on our Pb-Free strategy and soldering details, please download the ON Semiconductor Soldering and Mounting Techniques Reference Manual, SOLDERRM/D.

NCP4523

ON Semiconductor and **ON** are registered trademarks of Semiconductor Components Industries, LLC (SCILLC). SCILLC reserves the right to make changes without further notice to any products herein. SCILLC makes no warranty, representation or guarantee regarding the suitability of its products for any particular purpose, nor does SCILLC assume any liability arising out of the application or use of any product or circuit, and specifically disclaims any and all liability, including without limitation special, consequential or incidental damages. "Typical" parameters which may be provided in SCILLC data sheets and/or specifications can and do vary in different applications and actual performance may vary over time. All operating parameters, including "Typicals" must be validated for each customer application by customer's technical experts. SCILLC does not convey any license under its patent rights nor the rights of others. SCILLC products are not designed, intended, or authorized for use as components in systems intended for surgical implant into the body, or other applications intended to support or sustain life, or for any other application in which the failure of the SCILLC product could create a situation where personal injury or death may occur. Should Buyer purchase or use SCILLC products for any such unintended or unauthorized application, Buyer shall indemnify and hold SCILLC and its officers, employees, subsidiaries, affiliates, and distributors harmless against all claims, costs, damages, and expenses, and reasonable attorney fees arising out of, directly or indirectly, any claim of personal injury or death associated with such unintended or unauthorized use, even if such claim alleges that SCILLC was negligent regarding the design or manufacture of the part. SCILLC is an Equal Opportunity/Affirmative Action Employer. This literature is subject to all applicable copyright laws and is not for resale in any manner.

PUBLICATION ORDERING INFORMATION

LITERATURE FULFILLMENT:

Literature Distribution Center for ON Semiconductor
P.O. Box 61312, Phoenix, Arizona 85082-1312 USA
Phone: 480-829-7710 or 800-344-3860 Toll Free USA/Canada
Fax: 480-829-7709 or 800-344-3867 Toll Free USA/Canada
Email: orderlit@onsemi.com

N. American Technical Support: 800-282-9855 Toll Free
USA/Canada

Japan: ON Semiconductor, Japan Customer Focus Center
2-9-1 Kamimeguro, Meguro-ku, Tokyo, Japan 153-0051
Phone: 81-3-5773-3850

ON Semiconductor Website: <http://onsemi.com>

Order Literature: <http://www.onsemi.com/litorder>

For additional information, please contact your
local Sales Representative.